



FMX7

Dimensions (mm)	External	Internal
Height	501	
Width	333	
Depth	430	
Capacity (ltr)		
Gross		7
Net		



FMX10

Dimensions (mm)	External	Internal
Height	612	
Width	383	
Depth	456	
Capacity (ltr)		
Gross		10
Net		



FMX20

Dimensions (mm)	External	Internal
Height	755	
Width	505	
Depth	550	
Capacity (ltr)		
Gross		20
Net		



FMX30

Dimensions (mm)	External	Internal
Height	1138	
Width	605	
Depth	320	
Capacity (ltr)		
Gross		30
Net		

Features

- Three speed settings
- Lever operated bowl lift
- Safety stop function
- Bowl guard
- Stainless steel bowl
- Supplied with wire whisk, dough hook & beater

Additional Extras

- BZ-MX600 - Mixer stand for FMX7/10/20/30
- B3-MX11582 - Mixing bowl for FMX10
- B3-MX201155 - Mixing bowl for FMX20
- B3-MX301185 - Mixing bowl for FMX30



Technical Specification

	FMX7	FMX10	FMX20	FMX30
Power Supply	13amp	13amp	13amp	15amp
Power Usage (w)	650	550	1100	1500
Weight (kg)	27.5	45	80	148

FMX7

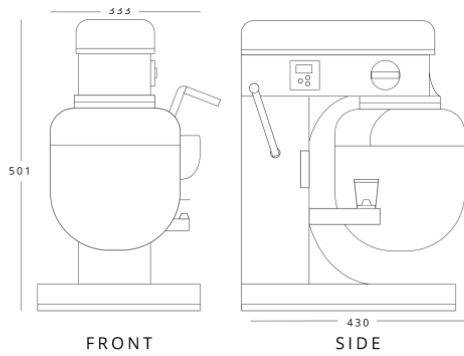

FMX10

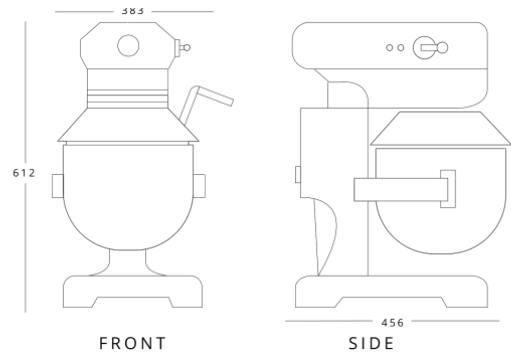

FMX20

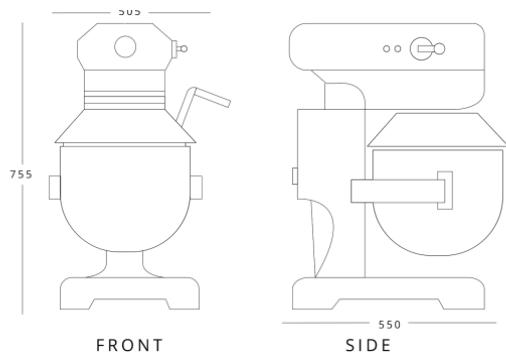

FMX30

