



BLAST CHILLER

Installation, Operation & Maintenance Manual



BCF20,40 & 60 Models

**PLEASE READ THE MANUAL THOROUGHLY PRIOR TO
EQUIPMENT SET-UP, OPERATION AND MAINTENANCE**

TABLE OF CONTENTS

◆ INSTALLATION	1
Cabinet location and installation guidelines.....	1
Electrical safety	2
◆ OPERATION	3
General use of the cabinet	3
Operation instruction for temperature controller	4
◆ REGULAR MAINTENANCE	10
Cleaning the condenser coil.....	10
Cleaning the fan blade and motor.....	11
Cleaning the interior of unit.....	11
◆ TROUBLE SHOOTING	12
◆ TECHNICAL SPECIFICATION	13

**IMPORTANT SAFETY INSTRUCTIONS, READ CAREFULLY
AND KEEP FOR FUTURE REFERENCE**

INSTALLATION

IMPORTANT!!! PLEASE READ BEFORE INSTALLATION

- If the unit has recently been transported. Please let unit stand still for a minimum of 24 hours before plugging it in.
- Make sure that there is proper ventilation around the unit in the where it will operate.
- Make sure all accessories are installed before plugging the unit in.
- Please read through the manual in its entirety.
- Disposal of old equipment should be done responsibly as per WEEE regulations and local authority directives.

CABINET LOCATION AND INSTALLATION GUIDELINES

■ Unpacking

The unit is delivered on a pallet and shrink-wrapped. Documentation is inserted into a clear pocket located inside the unit. Carefully remove the protective plastic film and cardboard from the unit exterior and from the door opening surround making sure that any sharp instrument used does not cause damage, plus remove any quality labels.

■ Install the unit on strong and leveled surfaces

- unit may make unpleasant noises if surface is uneven
- unit may malfunction if surface is uneven
- If the floor is not flat, please use something to make sure the base of this unit in horizontal level

■ Install the unit in an indoor, well-ventilated area

- unit performs more efficiently in a well-ventilated area Ensure the maximum design ambient temperature is not exceeded
- for best performance, please maintain clearance of 100mm / 4" on the back of the unit, 50mm / 2" on the top of the unit.

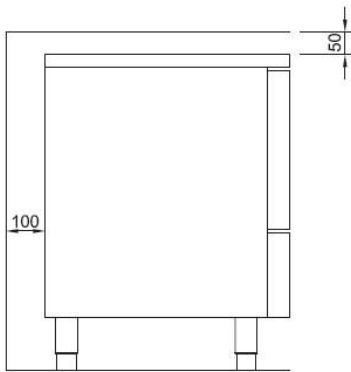

— outdoor use may cause decrease efficiency and damage to the unit

■ **Avoid installation in a high humidity and/or dusty area**

— humidity could cause unit to rust and decrease efficiency of the unit

— dust collected on condenser coil will cause unit to malfunction. Clean the condenser at least once a month with a brush or clean cloth

■ **Select a location away from heat and moisture-generating equipment**

— high ambient temperature will cause the compressor to overwork, leading to higher energy bills and gradual breakdown of the unit

■ **The appliance shall not be exposed to rain, sun**

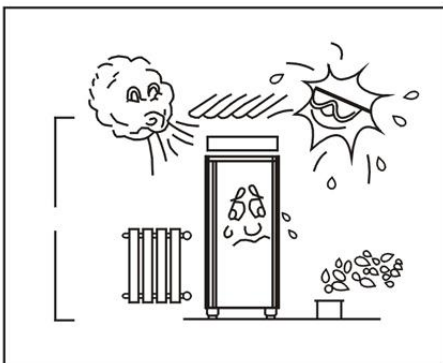

! *The cabinet must not be located in a chloride / acid-containing environment (swimming-bath etc.) due to risk of corrosion.*

CAUTION: PROBLEMS CAUSED BY UNPROPER POSITION OF UNITS ARE NOT COVERED BY WARRANTY

■ **The castor is with a brake, turn it to different side can lock or unlock the castor**



ELECTRICAL SAFETY

■ **Please ensure that the required voltage of the compressor is being supplied at all times**

CAUTION: Low or high voltage can detrimentally affect the refrigeration unit.

- All units should be plugged into a grounded and properly-sized electrical outlet with appropriate overcurrent protection. Please refer to the electrical requirement on the nameplate.

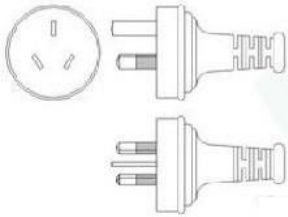

If you do not have the right outlet have a certified electrician install the correct power source.



To minimize shock and fire hazards, be sure not to overload outlet. Please designate one outlet for your unit., make sure that the unit is properly grounded.

- Please make sure that your unit has its own dedicated outlet. Do not use an extension cord.



- When the unit is not in use for a long period of time, please unplug the unit from the outlet.
- After unplugging the unit, wait at least 10 minutes before re-plugging it. Failure to do so could cause damage to the compressor.
- Do not attempt to alter or tamper with the electrical cord.

OPERATION

GENERAL USE OF THE CABINET

Blast chiller & freezer quickly reduce the core temperature of the products, whether they are cooked or fresh, conserving their fresh texture, hygiene and quality, whilst reducing the risk of bacteria generating.

The traditional method of storing cooked food has always been to leave it to cool naturally until it reaches a suitable temperature to store in the refrigerator.

During the period when the core temperature falls from +65°C and +10°C, the food will lose a lot of its natural characteristics, such as moisture, consistency, aroma and color. These blast chillers & freezers are designed to reduce the time period for this critical change in temperature.

■ **The storage cabinet is designed to fit two kinds of pans**



- * GN 1/1 pan
- * 400x600 EN pan

When blast chilling always use metal or foil containers which are good conductors. Plastic or polyurethane containers insulate the food from the cold air. When chilling unportioned food we recommend the use of the appropriate gastronorm tray or similar, depth of tray to be max of 50mm.

■ **Loading food**

Attention: Make sure that the unit drops down to desired temperature before loading the unit with food DO NOT overload the cabinet observe the max product weight.

- The maximum temperature of food entering the Blast Chiller/Blast Freezer must not exceed +80°C (176°F). Regulations state that product should be placed in the Blast Chiller/Blast Freezer within 30 minutes from completion of cooking.
- The packaging of food and the way in which it is loaded or placed within the equipment can have a significant effect on the time within which the temperature can be reduced to the require level and the amount of food which can be processed in each chilling or freezing batch. (Maximum food thickness 50mm).

■ **It is important to insert the probe correctly.**

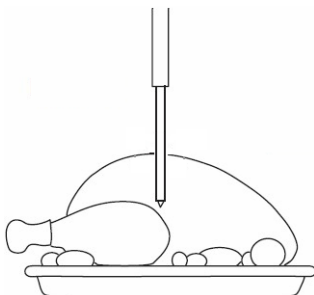

The needle of probe should be inserted until the point reaches the center of the foodstuff.

OPERATION INSTRUCTION FOR TEMPERATURE CONTROLLER

The unit has been created for fast chilling or freezing goods according to international food safety standards.

There are FOUR types of cycles:

- The CYCLES: Cy1, Cy2, Cy3, Cy4 are pre-set according to the most common cycles used in food -safety applications; the user can select one of them according to his own requirements and modify it as he wants.
- Any cycle can be manually terminated before the normal.
- Any cycle can use the insert probes (up to 3), they measure the internal temperature of the product.

- During the Cycle there are no defrosts and the fans are always on, a defrost cycle can be done before any freezing cycle.
- The cycle is divided up to 3 phases completely configurable by the user.
- Each instrument is provided with an output for remote display XR REP, which shows the temperature of cabinets or goods.
- The controller is provided with internal real time clock and can be connected to the printer. This means that a report, which includes all the main features of cycle, can be printed: start and end of the cycle, length of the cycle, logging of the temperature of the cabinet and goods.

■ Frontal panel



■ Quick start

1. DISPLAY

The upper display shows the temperature of the room probe.

The lower display shows the temperature of the inserts probe or the count down timer. To pass to the one insert probe to the another one use the DOWN key.

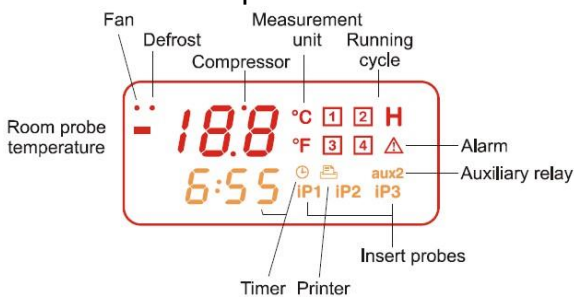

- Temperature.
- Timer or insert probe
- Alarm and status icons.

If an icon or LED is on, the correspondent function is enabled.

If an icon or LED is flashing, the correspondent function is delayed.

2. KEYBOARD IN STAND BY

HOW TO SELECT A CYCLE:

Push and release the **P** (3) key till the desired cycle is selected.

HOW TO START A CYCLE: Push and release the START/STOP **START/STOP** button (2). If the correspondent yellow LED is switched on..

HOW TO TEMPORARILY STOP THE RUNNING CYCLE.

1. Press and release the **START/STOP** key.

2. The compressor and the fan will be stopped for the PAU time (see parameters list) and the flashing

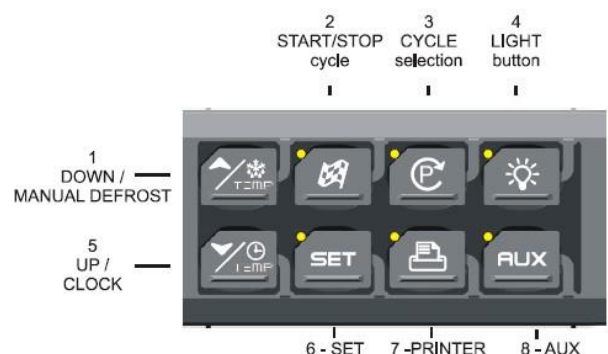

message "Stb" will be displayed.

3. To restart the cycle press and release the  key, the cycle will restart from the same point at which it was interrupted.

4. In any case the cycle automatically restarts after the PAU time.

HOW TO STOP A CYCLE: hold pushed the START/STOP  button (2) till the yellow LED will be switched Off.

HOW TO SET THE TIME (RTC) Must be done from initial use.

Hold pushed the **DOWN** key (5) till the Min label is displayed.

Use the **UP** and **DOWN** KEY to browse the parameters.

TO MODIFY: push the **SET** button and then the UP and DOWN keys.

TO CONFIRM: push the **SET** button.

TO EXIT THE RTC MENU: Push together SET + UP keys or wait 5 sec.



UP key: browse the menu:
 - Min= minutes
 - Hou= hours
 - daY= day
 - Mon= month
 - YEA= year
 - tiM= US/EUROPE time

HOW DISPLAY / MODIFY THE SET POINT OF THE HOLDING PHASE

TO DISPLAY: Push and release the **SET** key (6), the holding set point of the selected cycle is displayed for 5 sed..

TO MODIFY: while the set point is displayed hold pushed the SET key till the HdS label start flashing. Use the UP and DOWN key to modify the value.

TO CONFIRM: push the SET key to confirm the value and exit.

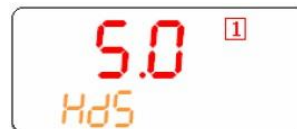

In this exemplum the holding set point of the cycle 1 is modified.



In this exemplum the set point of the holding cycle is modified.

HOW MODIFY A CYCLE:

1. Push the  key (6) for several seconds till the first parameter (CyS) is displayed.
2. Use the UP and DOWN keys to browse the parameters.
3. To modify a parameter push the SET key and use the arrow keys.
4. Confirm the new value by pushing the SET key.
5. The new value is recorded even if the programming is exited by time out.

3. KEYBOARD WHEN A CYCLE 1,2,3,4 IS RUNNING

DISPLAY TEMPERATURE: The **upper** display shows the temperature of the thermostat probe. The **bottom** display shows the temperature of a insert probe (if enabled) or the count down timer. By pushing the **DOWN** key the probes iP1, iP2, iP3 and the count down timer are displayed in sequence.

PHASE DISPLAY: pushing the **UP** key the running phase is displayed.

HOW TO DISPLAY THE REGULATION SET POINTS

By pushing the SET key the following information are displayed in sequence:



PH1= phase 1
 PH2= phase 2
 PH3= phase 3



- **rSI** = Room set point
- **iSI** = Stop phase set point, referred to the insert probe
- Back to the room temperature.

HOW TO MODIFY THE ROOM SET POINT

While rSI or iSI are displayed hold pushed the SET key till the rSi or iSi label start flashing and LED near the SET key is turned on.

Use the arrow key to modify the value and the SET key to confirm it.



4. KEYBOARD WHEN THE HOLDING CYCLE IS RUNNING (H)

HOW TO DISPLAY THE HOLDING (REGULATION) SET POINT

While the holding cycle is running, (H icon lighted), push the SET key and the holding set point is displayed on the UPPER display while the **SETH** label on the bottom display.

HOW TO MODIFY THE ROOM SET POINT

While SETH is displayed hold pushed the SET key till the SETH label starts flashing and LED near the SET key is turned on. Use the arrow key to modify the value and the SET key to confirm it.

TO CONFIRM AND EXIT: push again the SET key



5. OTHER KEYS

LIGHT (4): push the LIGHT (4) key to switch the light on and off. The status of the light is monitored by the yellow LED upper the key.

AUX (8): push the AUX (8) key to switch the auxiliary on and off. The status of the auxiliary relay is monitored by the yellow LED upper the key.

PRINTER / H (7): push the PRINTER key when the keyboard is connected to the controller, to enabled/ disable the printer.

PRINTER CONFIGURATION MENU

Push the PRINTER (7) key for few seconds to enter the printer configuration menu. The **itP**, label is displayed, use the ARROW keys to browse the parameters

To modify: push the **SET** key and then the ARROW keys.

To confirm: push the **SET** key

To exit the Printer menu: Push together SET + UP keys or wait 5 sec

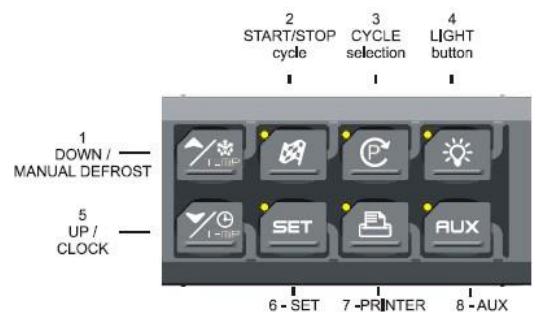

- UP key:** browse the menu:
- **itP**= time printing interval.
 - **PbP**= data to print.
 - **PAr**= enabled the printing of the parameter map.
 - **Cyc**= enabled the printing of cycle parameters .
 - **PtH**= enabled the printing during the holding phase.
 - **PrS**= level Pr1 o Pr2.
 - **Pnu**= number of printing.

DOWN key back to the previous label.







6. HOW TO START A MANUAL DEFROST.

Assure that none cycle is active or the hold mode is running.

Hold press the **UP** key for few seconds.



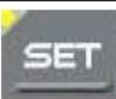



NOTE: The defrost will not be done if the temperature detected by the evaporator probe is higher than EdF (stop defrost temperature) parameter.



7. OTHER FUNCTIONS OF KEYBOARD

 + 	To lock & unlock the keyboard Pon/PoF
 + 	To enter the programming mode when the controller is in stand-by Each parameter present in the Pr2 can be removed or put into "Pr1" (user level) by pressing "SET + ▼".
 + 	To return to the previous menu.

8. MEANING OF THE LEDS'

A series of light points on the front panels is used to monitor the loads controlled by the instrument. Each LED function is described in the following table.

LED	MODE	ACTION
	ON	- Compressor enabled
	Flashing	- Programming Phase (flashing with LED ) - Anti-short cycle delay enabled
	ON	- Fans enabled
	Flashing	- Programming Phase (flashing with LED ) - Activation delay active
	ON	- Defrost active

LED	MODE	ACTION
	Flashing	- Drip time active
①②③④ H	ON	- Freezing cycle 1, 2, 3, 4 or hold mode active
①②③④ H	Flashing	- Instrument temporarily stop
	ON	- Alarm signalling
AUX – AUX2	ON	- Aux or Aux2 enabled

9. HOW TO SELECT A CYCLE

1. Push the  to move among the cycles C1, C2, C3, C4 and the holding cycle. The related symbol on the display will be lighted and the cycle will be selected.

NOTE: to pass from a cycle to another one simply push the  key when the controller is in stand –by mode.

HOLD PHASE: To select **H** symbol pushing the 

Cycles are pre-set with the following values:

1. **Cy1:** for fast chilling and conservation of foods (hard +soft chill).
2. **Cy2:** for chilling and fast freezing of foods (hard +soft + freezing cycle).
3. **Cy3:** for direct fast freezing (only fast freezing cycle)
4. **Cy4:** for fast freezing avoiding ice skin (hard chill + freezing cycle)
5. **HLd:** hold mode function
6. **dEF:** for starting a manual defrost

2. Now the cycle is memorised and can be activated.

HOW TO MODIFY A CYCLE

1. Verify that none cycle is running. If one cycle is running stop it by pushing the  key for 3s.
2. Push the **P** to move among the cycles C1, C2, C3, C4 and the holding cycle. The related symbol on the display will be lighted and the cycle will be selected
3. Hold push the **P** key for several seconds till the display will show the first parameter of the selected cycle (cyS) with its value.
4. Use the UP and DOWN keys to browse the parameters.
5. To modify a parameter push the SET key and use the arrow keys.
6. Confirm the new value by pushing the SET key.
7. The new value is recorded even if the programming is exited by time out.

TO exit: wait 30s or push the SET+UP keys.

10. HOW A CYCLE IS DONE

1. Every programmable cycle Cy1, Cy2, Cy3 or Cy4 can be divided into up to 3 phases usually called:

- **hard chill**
- **soft chill**
- **freezing cycle**

2. For each phase there are 3 parameters.

iS1, (iS 2, iS 3): Set point related to the insert probes that stops the current phase.

rS1, (rS2, rS3): set point of the room temperature for each phase.

Pd1, (Pd2, Pd3): the maximum duration time for each phase.

Hds : set point of the hold phase at the end of the whole cycle.

HOW TO USE THE INSERT PROBES.

By means the insert probe, the internal temperature of products can be checked. This measure is used to end the various phase of the cycle. A special internal function detects if the inset probe is not used, in this case the cycle is made by time

EXAMPLE OF A BLAST CHILLER CYCLE.

The following drawing explains how a Blast Chiller cycle can be done.

First phase: "Hard chill".

It is normally used to fast chill hot foods. E.g. from 80°C / 170°F to 20°C / 70°F.

During "Hard Chill", both compressor and fan are always on until the **rS1** temperature is reached. At this point compressor is turned on end off so as to keep the temperature of the room at the **rS1** value. "Hard Chill" ends when the temperature measured by the 3 insert probes reach the **iS1** value.

Second phase: "Soft chill".

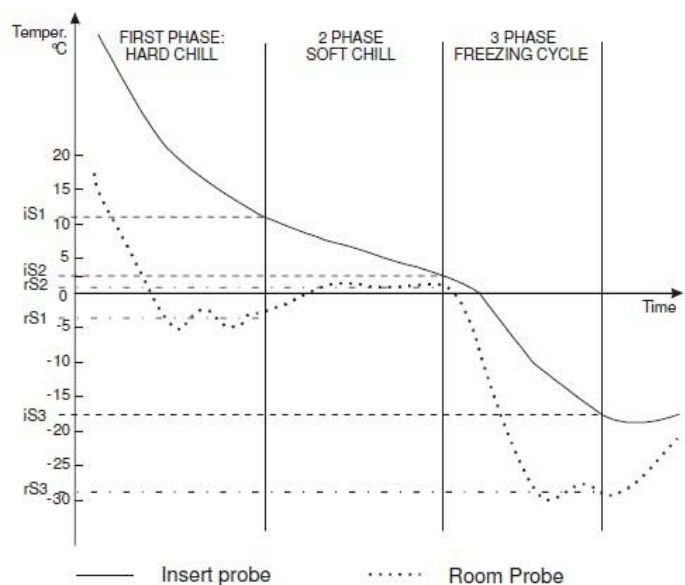

The **Soft Chill** starts when the Hard Chill ends. It is used to prevent thin layer of ice from forming on the product. The Soft Chill lasts until the temperature measured by the 3 insert probes reach the set point **iS2** (usually 4 or 5°C).

During Soft Chill the temperature of the room is regulated by the ambient probe with the set point **rS2** (normally at 0 or 1 °C / 32 or 34°F). When the box temperature reaches the **rS2** value compressor is turned on and off so as to keep the temperature of the box at this value.

Third phase: “Freezing cycle”.

Freezing Cycle: used to fast freeze foods.

The Freezing Cycle starts when the Soft Chill ends. During the “Freezing Cycle” both compressor and fan are always on until the **rS3** temperature is reached. At this point compressor and fans are turned on and off so as to keep the temperature of the room at the **rS3** value (normally some degrees below **iS3**). Freezing Cycle ends when the temperature measured by the 3 insert probes reach the **iS3** value

End of the Blast Chill cycle and starting of the Hold Mode.

When one of the three insert probes reach the **iS3** value the values End followed by the **i1P** or **i2P** or **i3P** are shown on the display.

Cycle ends when all the probes have reached the **iS3** value. A signal is generated buzzer and alarm relay is turned ON, the display shows the message “End” alternating with the room temperature.

The alarm automatically stops after the “**but**” time or by pressing any keys.

At the end of the cycle the controller can start the “Hold mode” keeping the room temperature at the value set in **HdS** parameter.

If **HdS** = OFF, the machine is turned OFF.

NOTE1: with **dbH = yES** a defrost is done before the holding phase.

NOTE2: If the end cycle temperature **iS3** is not reached in the maximum time **Pd1+Pd2+Pd3** the instrument keep on working, but the alarm message “**OCF**” is given.

REGULAR MAINTENANCE



Before maintenance and cleaning, please unplug the unit, do not plug or unplug the cord with wet hands.

CLEANING THE CONDENSER COIL

- For efficient operation, it is important that the condenser surface be kept free of dust, dirt, and lint.
- We recommend cleaning the condenser coil and fins at least once per month.
- Clean with a commercial condenser coil cleaner, available from any kitchen equipment retailer. Brush the condenser fins from top to bottom, not side to side.

- After cleaning, straighten any bent condenser fins with a fin comb

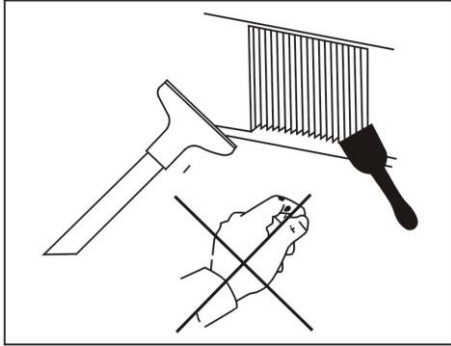

CLEANING THE FAN BLADE AND MOTOR

If necessary, clean the fan blades and motor with a soft cloth, if it is necessary to wash the fan blades, cover the fan motor to prevent moisture damage.

CLEANING THE INTERIOR OF UNIT

- When cleaning the cabinet interior, use a solution of warm water and mild soap.
- Do not use steel wool, caustic soap, abrasive cleaners, or bleach that may damage the stainless-steel surface.
- Wash door gaskets on a regular basis, preferably weekly. Simply remove door gasket from the frame of the door, soak in warm water and soap for thirty (30) minutes, dry with soft cloth, and replace.
- Check door gaskets for proper seal after they are replaced.
- Periodically remove the shelves and pilasters from the unit and clean them with mild soap and warm water. To remove the pilasters, first remove the shelves and shelf brackets. Then, simply lift the pilaster up and out.
- Ensure all stainless-steel surfaces are dried and apply stainless steel cleaner to exterior panels to preserve the finish

WARNING

Disconnect power cord before cleaning any parts of the unit.

TROUBLE SHOOTING

Before requesting any service on your unit, please check the following points.

Please note that this guide serves only as a reference for solutions to common problems.

SYMPTOM	POSSIBLE CAUSE	CORRECTIVE ACTION
Compressor not running.	Fuse blown or circuit breaker tripped. Power cord unplugged. Thermostat set too high. Cabinet in defrost cycle.	Replace fuse or reset circuit breaker. Plug in power cord. Set thermostat to lower temperature. Wait for defrost cycle to finish.
Condensing unit runs for long periods of time.	Excessive amount of warm product placed in cabinet. Prolonged door opening or door ajar. Door gasket(s) not sealing properly. Dirty condenser coil. Evaporator coil iced over.	Allow adequate time for product to cool down. Ensure doors are closed when not in use. Avoid opening doors for long periods of time. Ensure gaskets are snapped in completely. Remove gasket and wash with soap and water. Check condition of gasket and Replace if necessary. Clean the condenser coil. Unplug unit and allow coil to defrost. Make sure thermostat is not set too cold. Ensure that door gasket(s) are sealing properly.
Cabinet temperature is too warm.	Thermostat set too warm. Blocking air flow. Excessive amount of warm product placed in cabinet. Fuse blown or circuit breaker tripped. Dirty condenser coil. Prolonged door opening or door ajar. Evaporator coil iced over.	Set thermostat to lower temperature. Re-arrange product to allow for Proper air flow. Make sure there is at least four inches of clearance from evaporator. Allow adequate time for product to cool down. Replace fuse or reset circuit breaker. Clean the condenser coil. Ensure doors are closed when not in use. Avoid opening doors for long periods of time. (see above)
Cabinet is noisy.	Loose part(s). Tubing vibration.	Locate and tighten loose part(s). Ensure tubing is free from contact with other tubing or components.

Technical Specification

Model	Ref gas type	Ref gas charge (g)	Ext. Dimension (W*D*H mm)	wats (W)	Load (A)	Climate Class	Container capacity/ in GN1/1	Chilling capacity in 90mins/kg	Freezing capacity in 240mins/kg
BCF20-HC	R290	150	800*800*930	750	4.5	4	5	20	15
BCF40-HC	R290	150	800*800*1515	980	5.6	4	10	40	28
BCF60-HC	R290	150	800*800*1763	1200	6.2	4	13	60	38

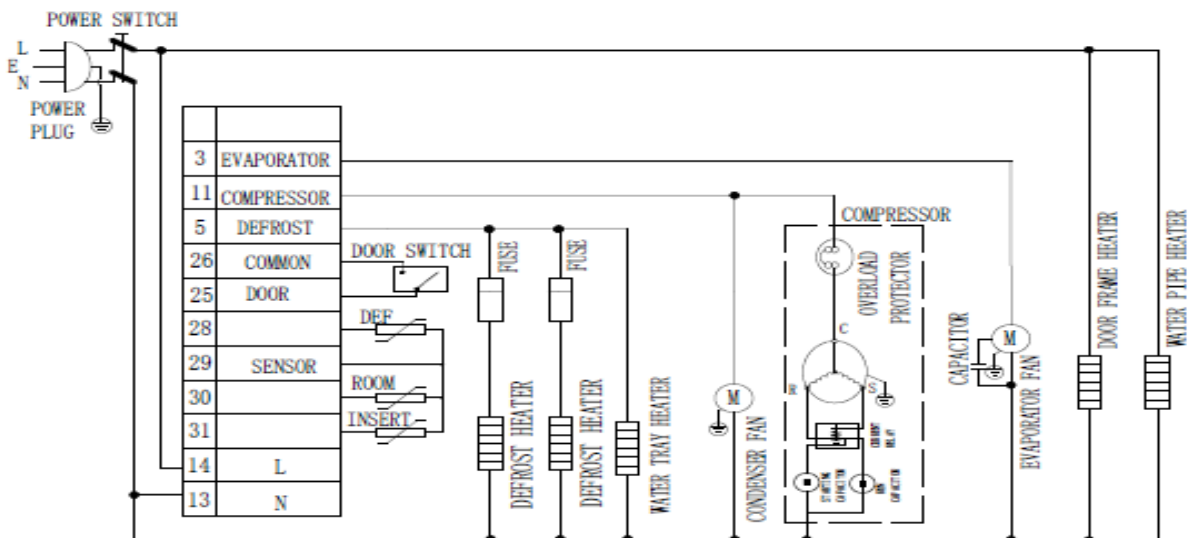
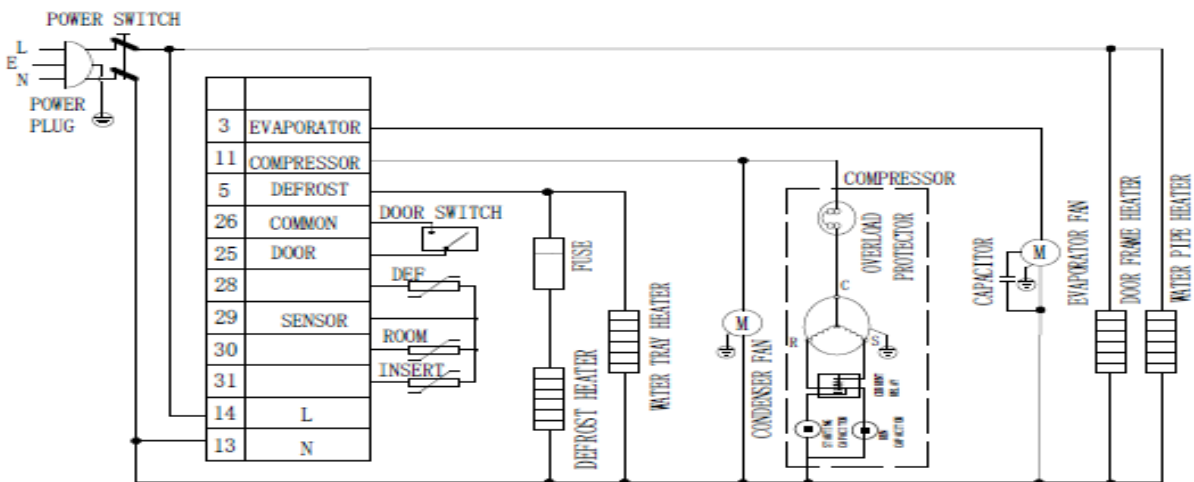

R290 refrigerant is used for this equipment.



Caution!

Consult repair manual/owner's guide before attempting to install or service this product. All safety precautions must be followed. Dispose of properly in accordance with federal or local regulations. Risk of fire or explosion due to puncture of refrigerant tubing. Follow handling instructions carefully.

Danger!

Risk of fire or explosion. Flammable refrigerant used. To be repaired only by trained service personnel. Do not use mechanical devices to defrost refrigerator. Do not puncture refrigerant tubing.

Disposal



EU regulations require refrigeration product to be disposed of by specialist companies who remove or recycle all gasses, metal and plastic components.

Consult your local waste collection authority regarding disposal of your appliance. Local authorities are not obliged to

dispose of commercial refrigeration equipment but may be able to offer advice on how to dispose of the equipment locally.

All packaging materials should be disposed of in an environmentally friendly way.

The cardboard may be used as scrap paper. The protective foil and the foam cushions are CFC-free.

Do not allow children to play with the packaging and destroy plastic gags safely.



Environmental protection

Discarded electric appliances are recyclable and should not be discarded in the domestic waste! Please actively support us in conserving resources and protecting the environment by returning this appliance to the collection centers (if available).

Compliance

Parts have undergone strict product testing in order to comply with regulatory standards and specification set by international, independent, and federal authorities. Products have been approved to carry the following symbols:

